

INSTALLATION MANUAL

MONTERINGSANVISNING
MONTERINGSANVISNING
MONTERINGSVEJLEDNING
ASENNUSOHJE

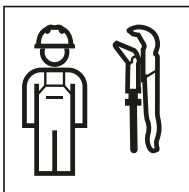

970-224-00-0(00)

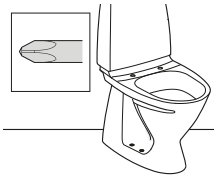

➔ **A** 2



➔ **B** 4

A

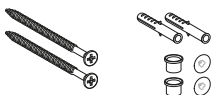
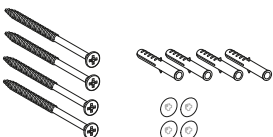
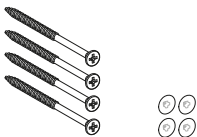

1

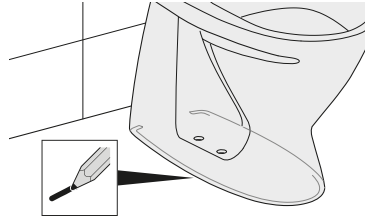

2

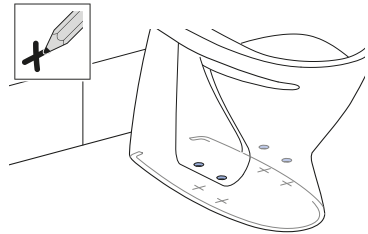

3

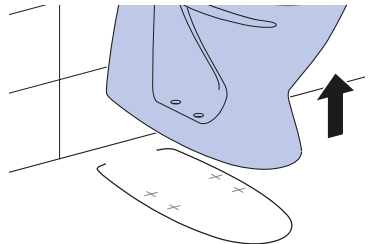

i

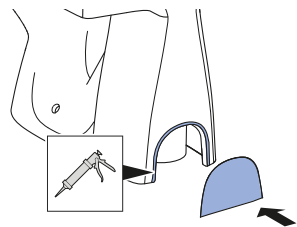

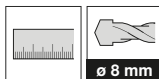

Seven D WC-10

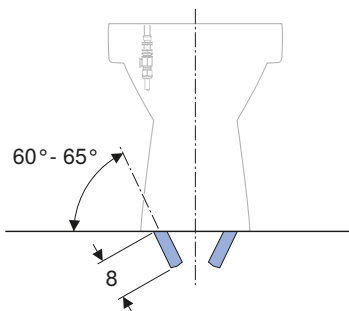

4



: SWE, FIN, DNK:
EN 15651-3, Class XS1

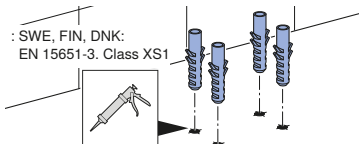

5

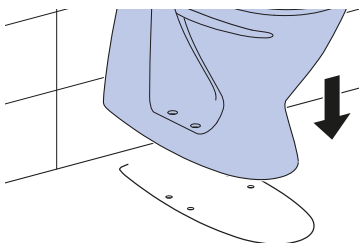

6

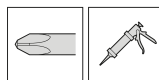

: SWE, FIN, DNK:
EN 15651-3, Class XS1

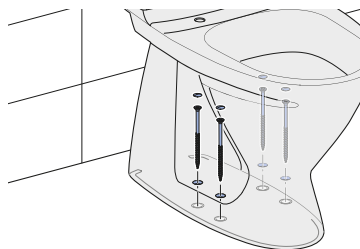

: SWE, FIN, DNK:
EN 15651-3, Class XS1

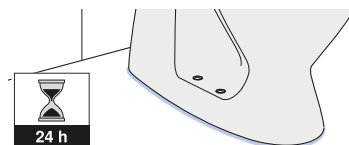

B



1

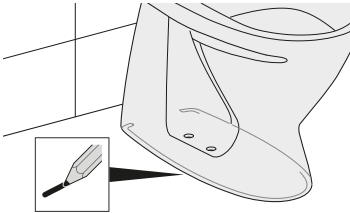

2

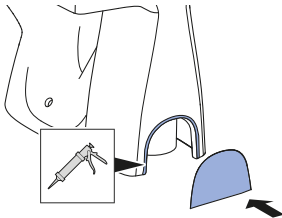
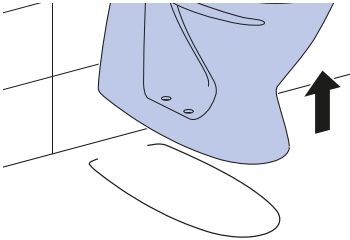

3

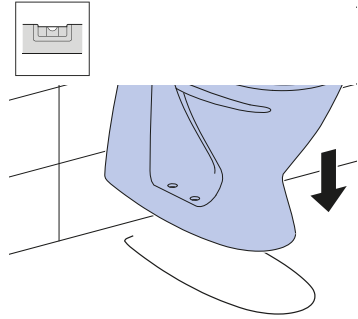

: EN 15651-3, Class XS1

Ø 5



24 h

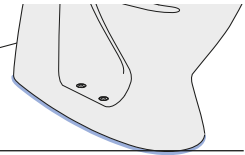

4



: EN 15651-3, Class XS1

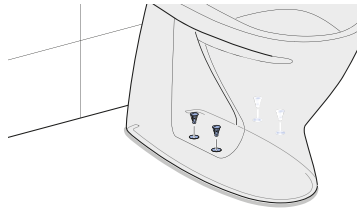

Geberit International AG
Schachenstrasse 77, CH-8645 Jona
documentation@geberit.com
www.geberit.com

